

DURAT®

## **RECYCLABLE DURAT MADE OF RECYCLED PLASTIC**

DURAT is a solid polyester based material used for custom made surfaces in public and private interiors. It contains recycled plastics and is itself 100% recyclable.

The sophistication of the DURAT material lies in its silky warm feeling and the interesting impression of depth in its finish.

DURAT is extremely durable and can be renewed by slight sanding. The material is very resistant to wear, humidity, and various kinds of chemicals.



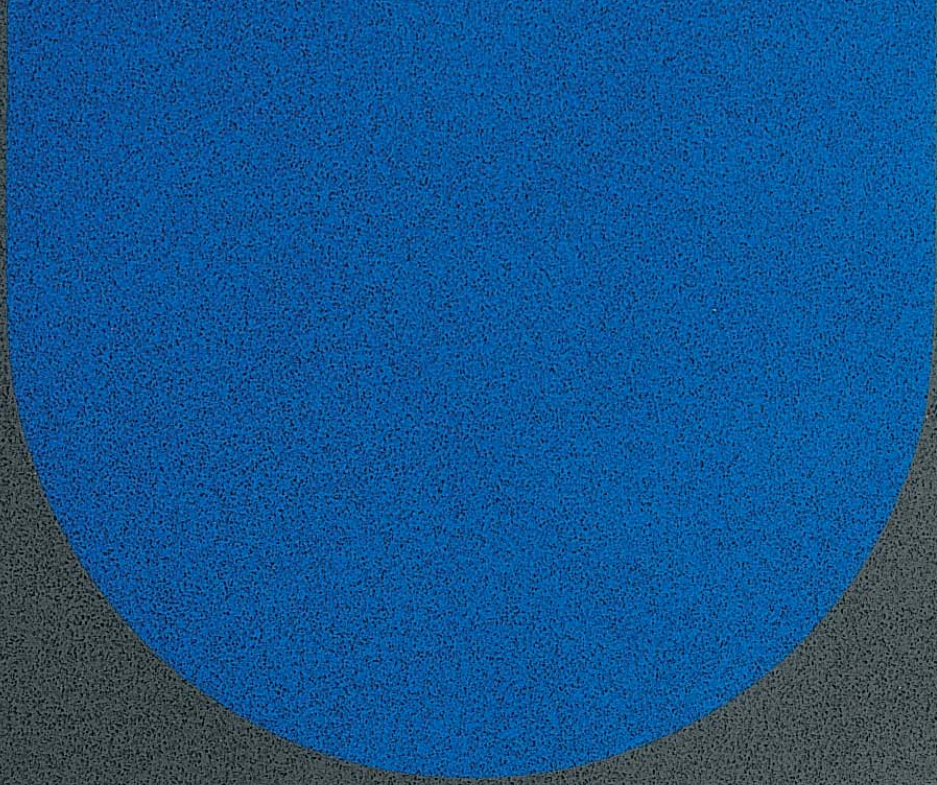

**MATERIAL FOR YOUR DREAMS**



## DURAT IS AN OPPORTUNITY

DURAT is an excellent material for surfaces of different kinds. DURAT is a natural choice in places like restaurants, cafes, shops, hospitals, laboratories, boats and ships, bathrooms and kitchens.

The DURAT material offers designers almost infinite opportunities to create various surfaces. The sheets can be used to create, for example, coherent, seamless surfaces tens of meters in length with various forms of edge design and intarsia patterns. The seams can be sanded down to make them almost invisible. The material is processed with woodworking tools.

DURAT has an extensive range of standard sink models to be used in custom made vanity units for bathrooms and public sanitary facilities.







RAITA BENCH

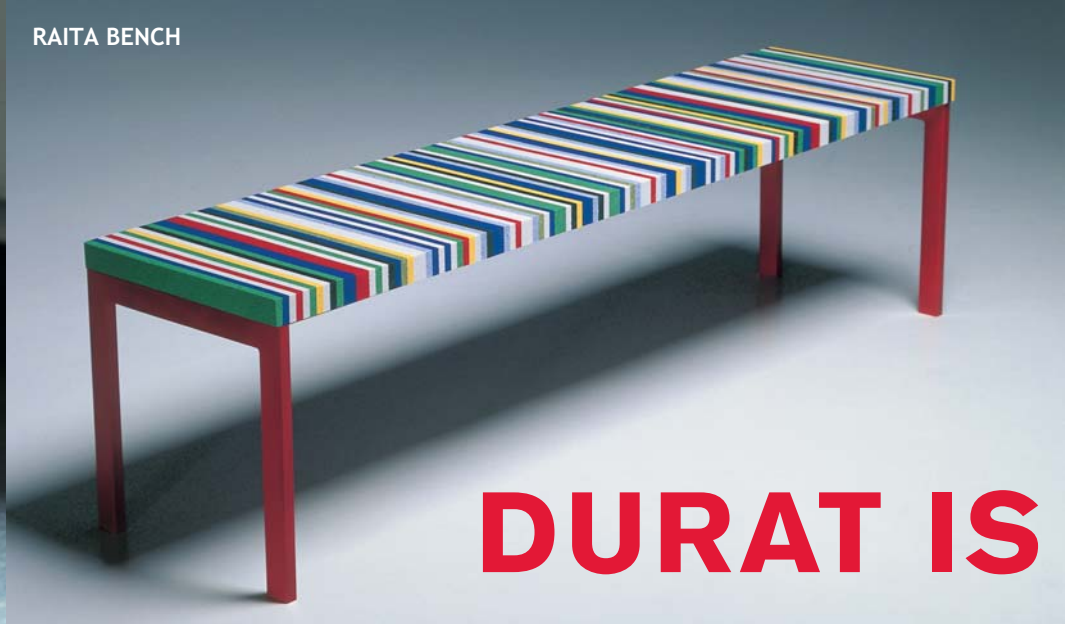

**DURAT IS**







RECTANGULAR WASH BASIN



# A PART OF DAILY LIFE



SOIKKO BATH TUB

A photograph of a storage cabinet with orange perforated walls and shelves. The cabinet is divided into three compartments by two vertical orange panels. Each compartment has two shelves. The shelves are made of a dark material with a grid of small holes. The lighting is warm, highlighting the texture of the perforated metal.

**DURAT GIVES TOOLS — SHELVES**

A high-angle photograph of a modern kitchen sink. The sink is a solid black rectangular unit with a minimalist design. It is set into a dark blue countertop with a fine white speckle pattern. A sleek, chrome faucet with a cylindrical body and a curved spout is mounted on the right side of the sink. In the center of the sink's basin is a circular chrome drain with a multi-hole pattern. The lighting is dramatic, creating strong highlights and shadows that emphasize the textures and materials.

**ETS, BASINS AND COLOURS**



## **DURAT – DISCREET OR COLOURFUL**

DURAT's colour chart is extensive. The three dimensional surface gives black, grey and even white a special sense of depth. The basic colours blue, red, green and yellow are also available in many fresh tones, and the selection also includes various cheerfully speckled alternatives. It is also possible to tint colours according to the customers' specific wishes.

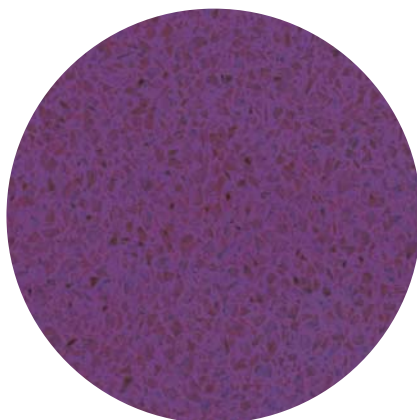
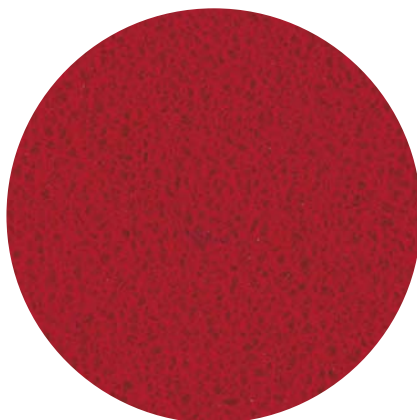
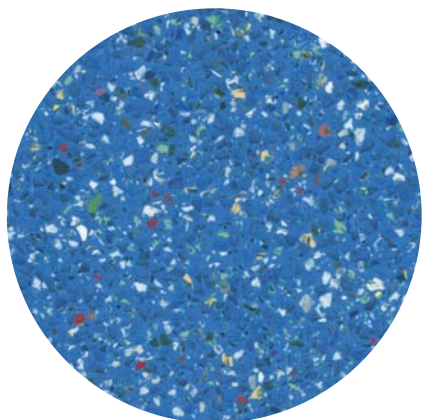

Due to technical reasons the printed colours may differ from the actual colours.

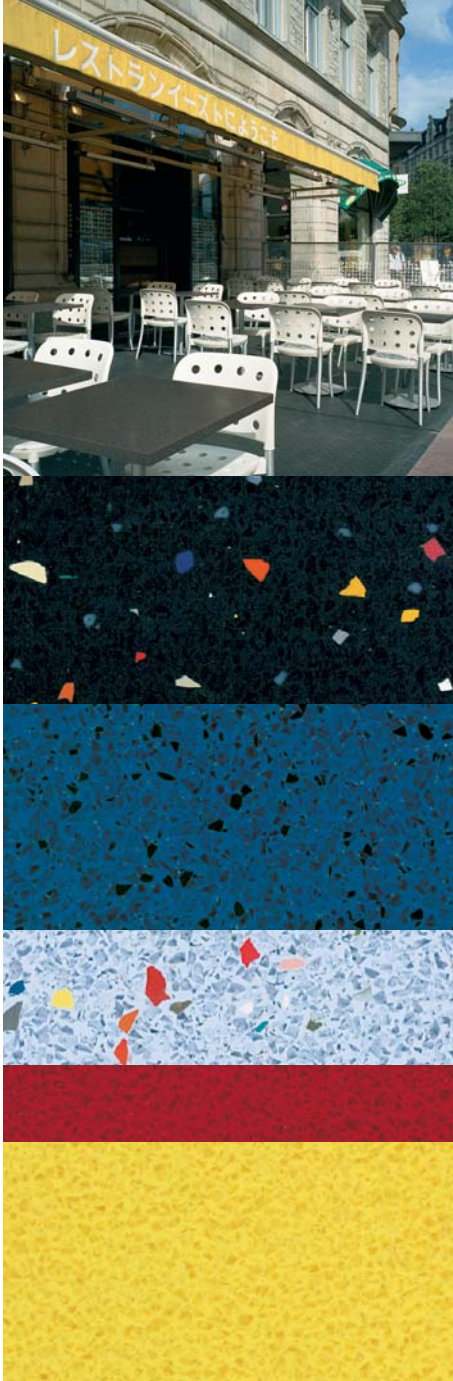

## TECHNICAL DETAILS

The standard thickness of the DURAT sheet is 12 mm. When making a DURAT top the sheet is backed up by a 12-18 mm thick plywood or mdf support. The seams are virtually unnoticeable.

Visible edges are finished in DURAT. The standard height of the edge of a worktop is 30 mm and the upper radius is 3 mm, but the dimensions can be specified individually.

Standard size	2900 x 800 mm
Thickness	12 mm
Barcol hardness	47 ±2
Tensile strength	25,8 ±1,4
Tensile modulus	3880 ±180 MPa
Strain at brake	0,75 % ±0,05
Heat expansion	0,0075 %/ °C

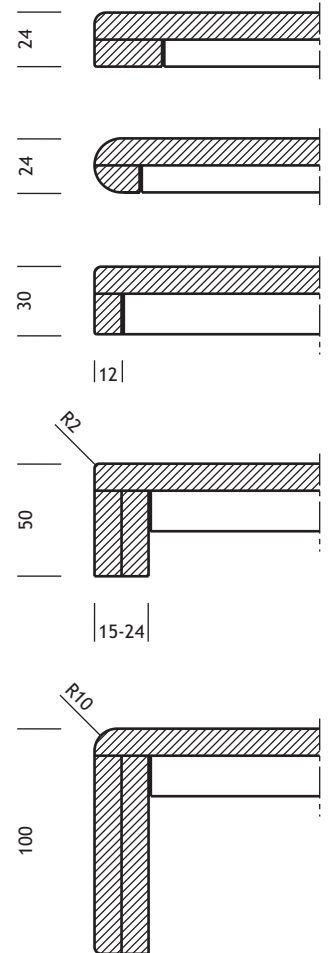

Examples of edge design



STUDIO KOSKINEN/RANTANEN

**DURAT**®

[www.durat.com](http://www.durat.com)

